

FUEGO COMPACT- MODEL: AEIR*TF

WAC ARCHITECTURAL

In-ground Luminaires

Project Name:

Type:

Product Image:



Line Drawing

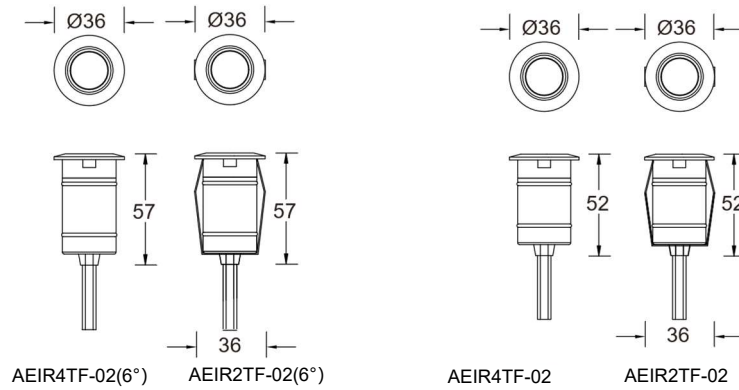

Product Description

Fuego Compact Stainless Steel Body Finish. Compact round design, IP67/IP68 rated, IK08 impact resistant. Resistant to pressurization up to 500 kg, pre-buried cylinder mounting, snap-on mounting.

Product Features

- **Body Materials:** Stainless steel lamp body
- **Optical System:** Lens
- **Finishes:** /
- **Objection Direction:** /
- **Accessory/Bracket:** Stainless steel snap/pre-embedded tube
- **Certification:** CQC
- **IP Rating:** IP67/IP68, IK08
- **Insulation Level:** Class III
- **Operating Temperature:** -20°C~50°C

Product Specifications

- **Opening Size:** AEIR2TF: ϕ 32mm ; AEIR4TF: ϕ 33mm
- **LED Type:** High Power LED
- **Power:** 1.6W Max
- **Source Lm:** 2700K 160lm /3000K 170lm /4000K 180lm
- **LED Lifetime:** >50000h-L70 /B10-Ta25°C(LM-80/TM-21)
- **CCT/CRI:** 2700K / 3000K / 4000K , Ra90; RGBW
- **SDCM:** 3 SDCM (MONO) , 5 SDCM (RGBW)
- **Input:** 12V-24V DC
- **Dimming:** ON-OFF / 0-10V dimming control / DMX512 dimming control
- **Net Weight:** Approx. 0.1Kg, excluding packaging

Order Model

Model	Power (W)	LEDs (quantity)	Max Lumens(lm)	Control Systems	Beam	CCT	Finish
AEIR2TF-02	2(Max)	1	67	ET ON-OFF	S 6°	27 2700K	SS Stainless Steel
				12-24V DC Power Supply	1 13°	30 3000K	
				MT DMX512 Dimming	2 21°	40 4000K	
				12-24V DC Power Supply	4 40°		
				DT 0-10V Dimming	W Wall Washer		
				12-24V DC Power Supply	P Surface-illuminated		

Example: AEIR2TF-02ETW27SS

WAC Lighting
www.waclighting.com (US)
www.waclighting.net (International)

Headquarters
44 Harbor Park Drive • Port Washington, NY
Phone (516) 515.5000 • Fax (516) 515.5050

WAC GROUP
TECHNOLOGY ILLUMINATED

FUEGO COMPACT- MODEL: AEIR*TF

In-ground Luminaires

WAC ARCHITECTURAL

Project Name:

Type:

Model	Power (W)	LEDs (quantity)	Max Lumens(lm)	Control Systems	Beam	CCT	Finish
AEIR2TF-02	2(Max)	1	9	MT DMX512 Dimming 12-24V DC Power Supply	P Surface-illuminated	F3 RGBW (W3000K) F4 RGBW (W4000K) F6 RGBW (W5700K)	SS Stainless Steel

Example: AEIR2TF-02MTPF3SS

Model	Power (W)	LEDs (quantity)	Max Lumens(lm)	Control Systems	Beam	CCT	Finish
AEIR4TF-02	2(Max)	1	67	ET ON-OFF 12-24V DC Power Supply MT DMX512 Dimming 12-24V DC Power Supply DT 0-10V Dimming 12-24V DC Power Supply	S 6° 1 13° 2 21° 4 40° W Wall Washer P Surface-illuminated	27 2700K 30 3000K 40 4000K	SS Stainless Steel

Example: AEIR4TF-02ETP27SS

Model	Power (W)	LEDs (quantity)	Max Lumens(lm)	Control Systems	Beam	CCT	Finish
AEIR4TF-02	2(Max)	1	9	MT DMX512 Dimming 12-24V DC Power Supply	P Surface-illuminated	F3 RGBW (W3000K) F4 RGBW (W4000K) F6 RGBW (W5700K)	SS Stainless Steel

Example: AEIR4TF-02MTPF3SS

Accessory

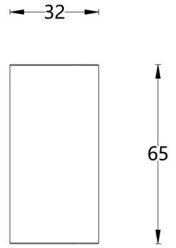
Item	Description	Pic	Description Dimensions
AEIR4TF-RC001	Recessed Casing		

FUEGO COMPACT- MODEL: AEIR*TF

In-ground Luminaires

WAC ARCHITECTURAL

Project Name:

Type:

Light Distribution Curve @3000K data

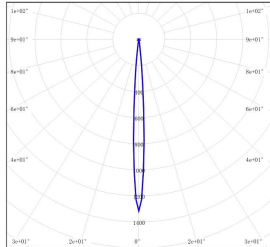

MODEL: AEIR4TF-02ETS30SS
AEIR2TF-02ETS30SS

BEAM ANGLE: 6°

POWER: 1.86W

LUMENS: 27 lm

CBCP: 1617cd

EFFICACY: 15 lm /W

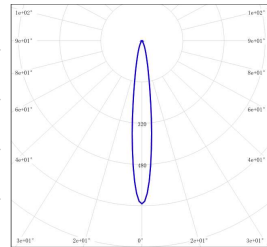

MODEL: AEIR4TF-02ET130SS
AEIR2TF-02ET130SS

BEAM ANGLE: 13°

POWER: 1.85W

LUMENS: 66 lm

CBCP: 632.2cd

EFFICACY: 35.81lm /W

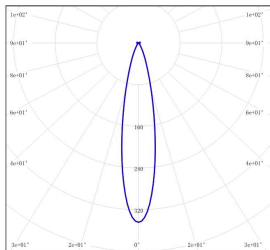

MODEL: AEIR4TF-02ET230SS
AEIR2TF-02ET230SS

BEAM ANGLE: 21°

POWER: 1.84W

LUMENS: 66 lm

CBCP: 349.3cd

EFFICACY: 35.85 lm /W

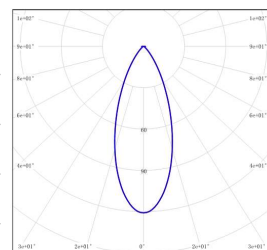

MODEL: AEIR4TF-02ET430SS
AEIR2TF-02ET430SS

BEAM ANGLE: 40°

POWER: 1.80W

LUMENS: 67 lm

CBCP: 120.9cd

EFFICACY: 37.21 lm /W

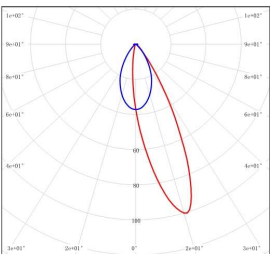

MODEL: AEIR4TF-02ETW30SS
AEIR2TF-02ETW30SS

BEAM ANGLE: Wall Washer

POWER: 1.86W

LUMENS: 41 lm

CBCP: 100.4cd

EFFICACY: 21.89 lm /W

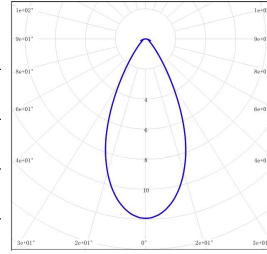

MODEL: AEIR4TF-02MTPF3SS
AEIR2TF-02MTPF3SS

BEAM ANGLE: Surface-illuminated

POWER: 2.54W

LUMENS: 9 lm

CBCP: 12.18cd

EFFICACY: 3.53 lm /W